

# LED STREET LIGHT



## SLR12



- 60mm Hole
- IP65 RATING
- 5 YEAR WARRANTY

### LED Street Light

LED Street light with a roud pole mounting hole.

Made of Aluminum alloy with high thermal heat management, design to spread out heat evenly.

Equip with long life, efficient and excellent LED driver and SMD LED, design with maximum distance and greatest heat dissipation through heat sink and heat management system.

Waterproof rate IP65

Built in with protection for short circuit/overload/over voltage/over temperature

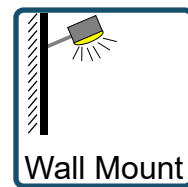
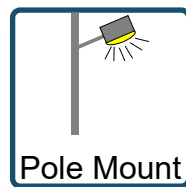

Partner with



# LED STREET LIGHT

### LED Street Light



### Lamp size

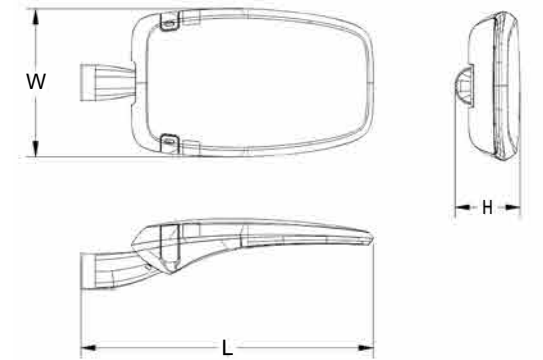

- Size
- 525x250x115mm
  - 600x320x120mm
  - 760x365x135mm
  - 830x410x150mm
  - 900x450x160mm

### Light Distribution

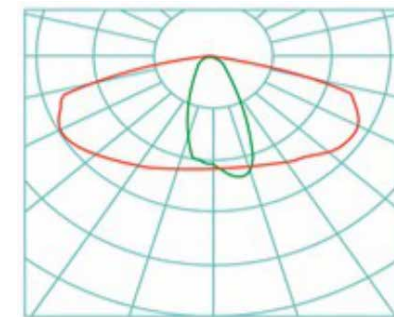

Bat 1

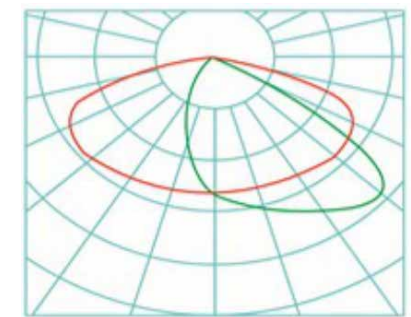

Bat 3

Model	System Power	CCT	Optics Light distribution	Voltage	Options	Size
SLR12	20/30/50W	40K 4000K	B1 Batwing type 1	MV 100-277VAC	DIM Dimming PH Photocell MS Motion sensor	525x250x115 mm
	50/60/80W	50K 5000K	B3 Batwing type 3			600x320x120mm
	80/100/150W	5700K 57K	120 120 degree	HV 347/480VAC		760x365x135mm
	150/180/200W	40 40 degree	80 80 degree			830x410x150mm
	240/300W	25 25 degree	40 40 degree			900x450x160mm

Note:

The Brand of LED and Driver can be customized due to client's request

The 12/24V DC is possible in 30W/40W for solar&wind power system. For greater wattage, contact for more detail.

We suggest choosing recommended light distributions unless you know how to select it for certain lighting application

# LED STREET LIGHT



SLR02



60mm Hole    IP65 RATING    5 YEAR WARRANTY

## LED Street Light

LED Street light with a roud pole mounting hole.

Made of Aluminum alloy with high thermal heat management, design to spread out heat evenly.

Equip with long life, efficient and excellent LED driver and SMD LED, design with maximum distance and greatest heat dissipation through heat sink and heat management system.

Waterproof rate IP65

Built in with protection for short circuit/overload/over voltage/over temperature

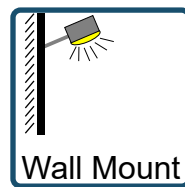
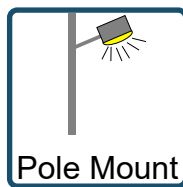

Partner with



# LED STREET LIGHT

## LED Street Light



## Lamp size

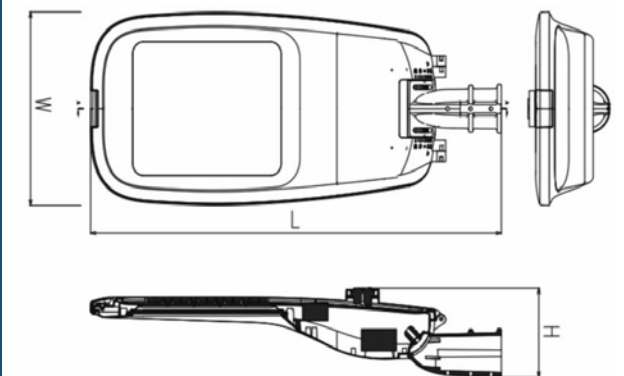

Size  
250x150x630mm  
300x150x720mm  
350x155x785mm

## Light Distribution

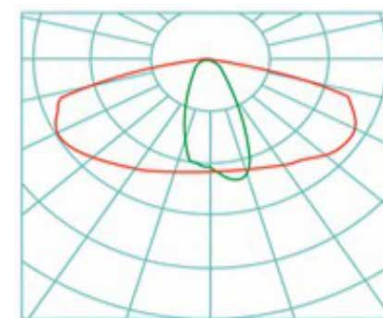

Bat 1

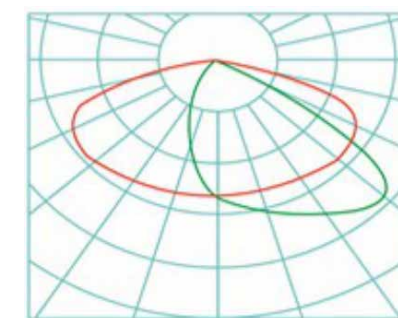

Bat 3

Model	System Power	CCT	Optics Light distribution	Voltage	Options	Size
SLR02	30/40/50/60 80W	40K 4000K	B1 Batwing type 1 B3 Batwing type 3	MV 100-277VAC	DIM Dimming PH Photocell MS Motion sensor	250x150x630 mm
	100/120/150W	50K 5000K	120 120 degree 80 80 degree	HV 347/480VAC		300x150x720mm
	180/200/240W	5700K 57K	40 40 degree 25 25 degree			350x155x785mm

Note:  
The Brand of LED and Driver can be customized due to client's request  
The 12/24V DC is possible in 30W/40W for solar&wind power system. For greater wattage, contact for more detail.  
We suggest choosing recommended light distributions unless you know how to select it for certain lighting application

# LED STREET LIGHT



## SLRT



60mm Hole    IP65 RATING    5 YEAR WARRANTY

### LED Street Light

LED Street light with a roud pole mounting hole.

Made of Aluminum alloy with high thermal heat management, design to spread out heat evenly.

Equip with long life, efficient and excellent LED driver and SMD LED, design with maximum distance and greatest heat dissipation through heat sink and heat management system.

Waterproof rate IP65

Built in with protection for short circuit/overload/over voltage/over temperature

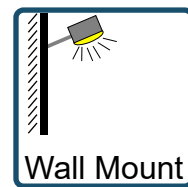
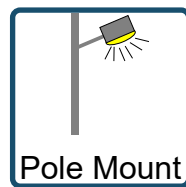

Partner with



# LED STREET LIGHT

## LED Street Light



## Lamp size

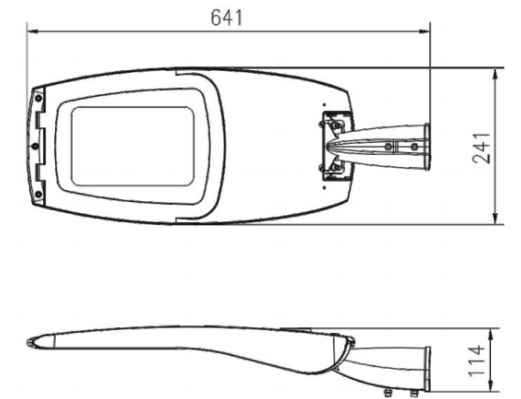

Size  
640x240x115mm  
740x290x115mm  
920x360x145mm

## Light Distribution

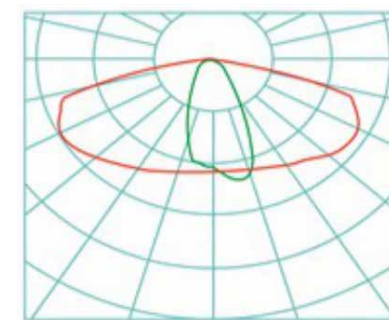

Bat 1

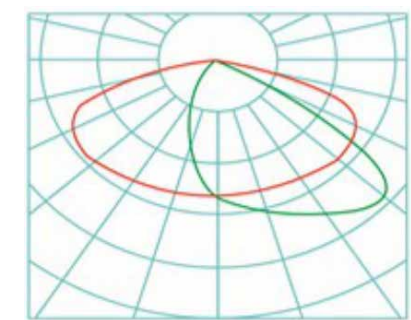

Bat 3

Model	System Power	CCT	Optics Light distribution	Voltage	Options	Size
SLRT	30/40/50/60W	40K 4000K	B1 Batwing type 1 B3 Batwing type 3	MV 100-277VAC	DIM Dimming PH Photocell MS Motion sensor	640x240x115 mm
	80/100/120W	50K 5000K	120 120 degree 80 80 degree	HV 347/480VAC		740x290x115mm
	150/180/200W	5700K 57K	40 40 degree 25 25 degree			920x360x145mm

Note:  
The Brand of LED and Driver can be customized due to client's request  
The 12/24V DC is possible in 30W/40W for solar&wind power system. For greater wattage, contact for more detail.  
We suggest choosing recommended light distributions unless you know how to select it for certain lighting application

# LED STREET LIGHT



SLR04



60mm Hole    IP65 RATING    5 YEAR WARRANTY

## LED Street Light

LED Street light with a roud pole mounting hole.

Made of Aluminum alloy with high thermal heat management, design to spread out heat evenly.

Equip with long life, efficient and excellent LED driver and SMD LED, design with maximum distance and greatest heat dissipation through heat sink and heat management system.

Waterproof rate IP65

Built in with protection for short circuit/overload/over voltage/over temperature

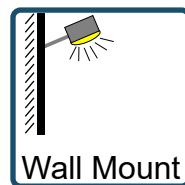
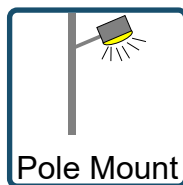

Partner with



# LED STREET LIGHT

## LED Street Light



## Lamp size

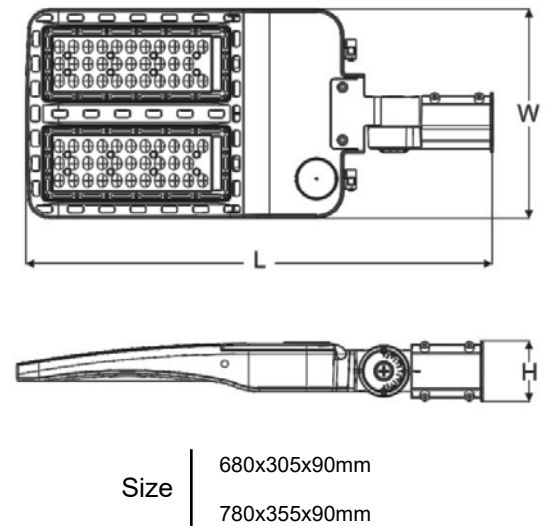

## Light Distribution

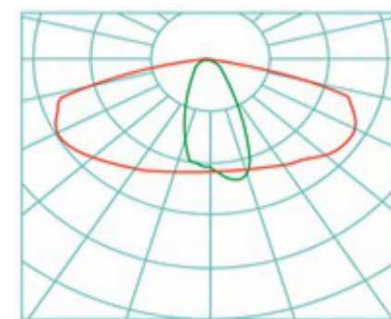

Bat 1

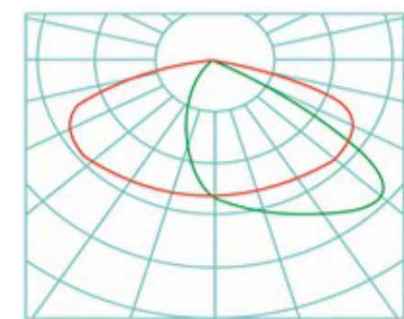

Bat 3

Model	System Power	CCT	Optics Light distribution	Voltage	Options	Size
SLR04	150/180/200W	40K 4000K 50K 5000K	B1 Batwing type 1 B3 Batwing type 3 120 120 degree 80 80 degree	MV 100-277VAC HV 347/480VAC	DIM Dimming PH Photocell MS Motion sensor	680x305x90 mm
	250/300/350W	5700K 57K	40 40 degree 25 25 degree			780x355x90 mm

Note:  
The Brand of LED and Driver can be customized due to client's request  
The 12/24V DC is possible in 30W/40W for solar&wind power system. For greater wattage, contact for more detail.  
We suggest choosing recommended light distributions unless you know how to select it for certain lighting application

# LED STREET LIGHT



T11A



- 60mm Hole
- IP67 RATING
- 5 YEAR WARRANTY

## LED Street Light

LED Street light with a round pole mounting hole.

Made of Aluminum alloy with high thermal heat management, design to spread out heat evenly.

Equip with long life, efficient and excellent LED driver and SMD LED, design with maximum distance and greatest heat dissipation through heat sink and heat management system.

Waterproof rate IP65

Built in with protection for short circuit/overload/over voltage/over temperature

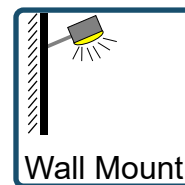
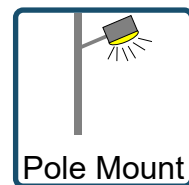

Partner with



# LED STREET LIGHT

## LED Street Light



## Lamp size

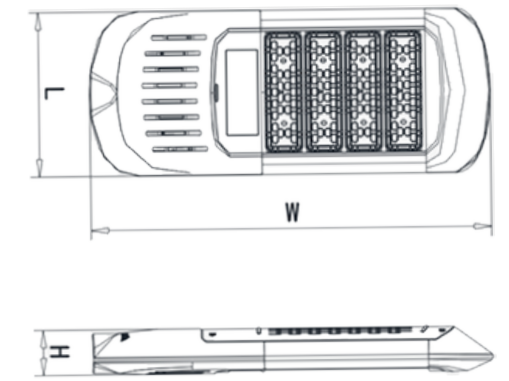

Size | See details in table below

## Light Distribution

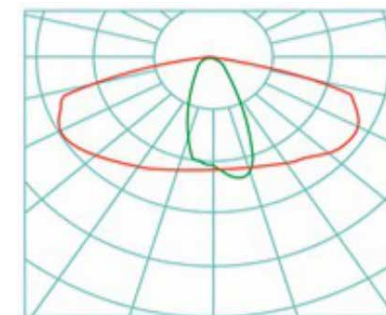

Bat 1

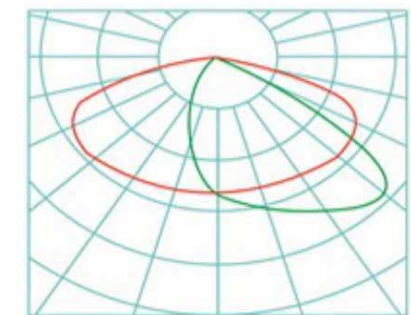

Bat 3

Model	System Power	Modular No.	CCT	Optics Light distribution	Voltage	Options	Size
T11A	40W	1	40K 4000K	B1 Batwing type 1	MV 100-277VAC	DIM Dimming	600x330x90 mm
	80W	2	50K 5000K	B3 Batwing type 3			645x330x90 mm
	120W	3		120 120 degree	HV 347/480VAC	PH Photocell	725x330x90 mm
	160W	4	80 80 degree	805x330x90 mm			
	200W	5	5700K 57K	40 40 degree	MS Motion sensor	885x330x90 mm	
	240W	6		25 25 degree		1065x330x90 mm	
	280W	7				1145x330x90 mm	

Note:

The Brand of LED and Driver can be customized due to client's request

The 12/24V DC is possible in 30W/40W for solar&wind power system. For greater wattage, contact for more detail.

We suggest choosing recommended light distributions unless you know how to select it for certain lighting application

# LED STREET LIGHT



T12A



60mm Hole    IP67 RATING    5 YEAR WARRANTY

## LED Street Light

LED Street light with a round pole mounting hole.

Made of Aluminum alloy with high thermal heat management, design to spread out heat evenly.

Equip with long life, efficient and excellent LED driver and SMD LED, design with maximum distance and greatest heat dissipation through heat sink and heat management system.

Waterproof rate IP65

Built in with protection for short circuit/overload/over voltage/over temperature

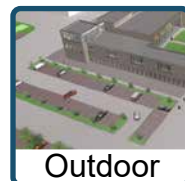
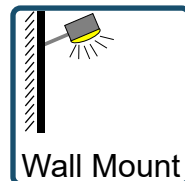
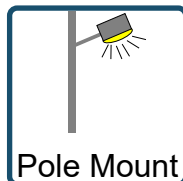

Partner with



# LED STREET LIGHT

## LED Street Light



## Lamp size

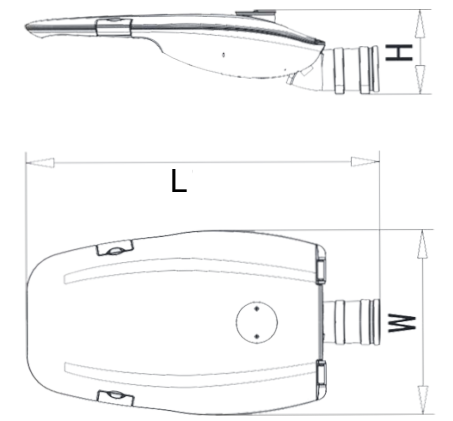

Size | See details in table below

## Light Distribution

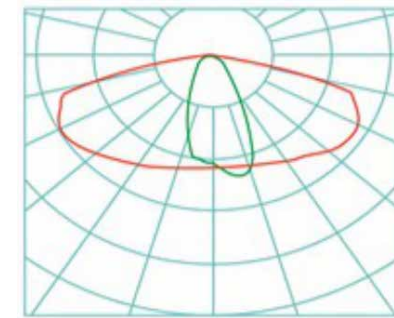

Bat 1

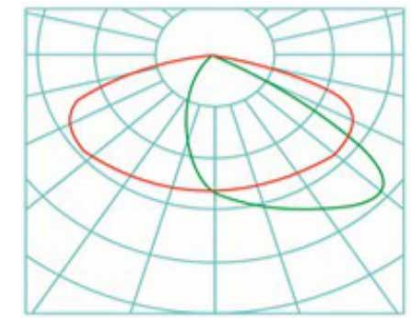

Bat 3

Model	System Power	Modular No.	CCT	Optics Light distribution	Voltage	Options	Size
T12A	40/60W	1	40K 4000K	B1 Batwing type 1 B3 Batwing type 3	MV 100-277VAC	DIM Dimming PH Photocell	630x330x150 mm
	80/100/ 120W	2	50K 5000K	120 120 degree 80 80 degree	HV 347/480VAC	MS Motion sensor	755x330x150 mm
	160/200/ 240W	4	5700K 57K	40 40 degree 25 25 degree			880x470x155 mm

Note:

The Brand of LED and Driver can be customized due to client's request

The 12/24V DC is possible in 30W/40W for solar&wind power system. For greater wattage, contact for more detail.

We suggest choosing recommended light distributions unless you know how to select it for certain lighting application

# LED STREET LIGHT



T19E



60mm Hole    IP67 RATING    5 YEAR WARRANTY

## LED Street Light

LED Street light with a round pole mounting hole.

Made of Aluminum alloy with high thermal heat management, design to spread out heat evenly.

Equip with long life, efficient and excellent LED driver and SMD LED, design with maximum distance and greatest heat dissipation through heat sink and heat management system.

Waterproof rate IP65

Built in with protection for short circuit/overload/over voltage/over temperature

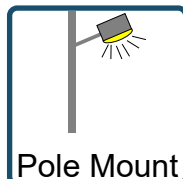

Pole Mount

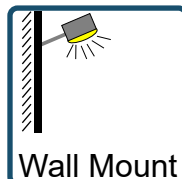

Wall Mount



Public



Outdoor

Partner with



# LED STREET LIGHT



## LED Street Light



## Lamp size

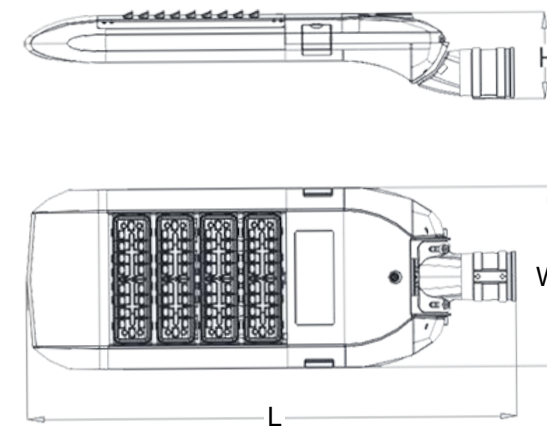

Size | See details in table below

## Light Distribution

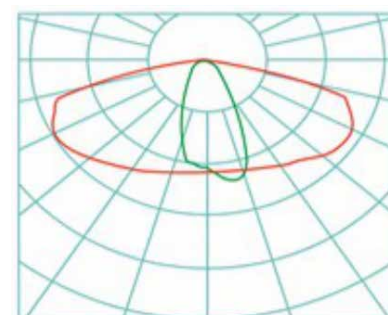

Bat 1

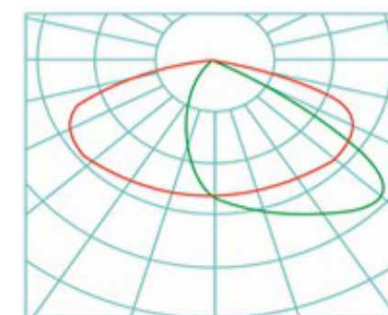

Bat 3

Model	System Power	Modular No.	CCT	Optics Light distribution	Voltage	Options	Size
T19E	40W	1	40K 4000K	B1 Batwing type 1	MV 100-277VAC	DIM Dimming	695x330x160 mm
	80W	2	50K 5000K	B3 Batwing type 3			740x330x160 mm
	120W	3		120 120 degree	PH Photocell	820x330x160 mm	
	160W	4		80 80 degree	MS Motion sensor	900x330x160 mm	
	200W	5	40 40 degree	980x330x160 mm			
	240W	6	25 25 degree	1060x330x160 mm			
	280W	7		1140x330x160 mm			

Note:

The Brand of LED and Driver can be customized due to client's request

The 12/24V DC is possible in 30W/40W for solar&wind power system. For greater wattage, contact for more detail.

We suggest choosing recommended light distributions unless you know how to select it for certain lighting application

# LED STREET LIGHT



T20A



60mm Hole    IP67 RATING    5 YEAR WARRANTY

## LED Street Light

LED Street light with a round pole mounting hole.

Made of Aluminum alloy with high thermal heat management, design to spread out heat evenly.

Equip with long life, efficient and excellent LED driver and SMD LED, design with maximum distance and greatest heat dissipation through heat sink and heat management system.

Waterproof rate IP65

Built in with protection for short circuit/overload/over voltage/over temperature

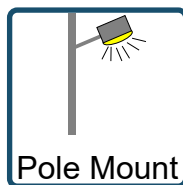

Pole Mount

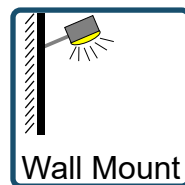

Wall Mount



Public



Outdoor

Partner with



# LED STREET LIGHT

## LED Street Light



## Lamp size

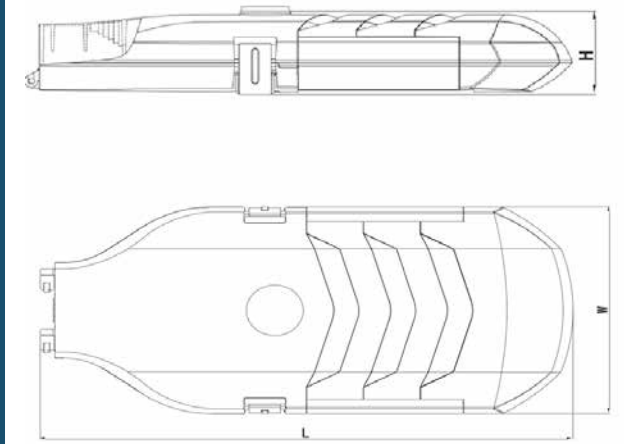

Size | See details in table below

## Light Distribution

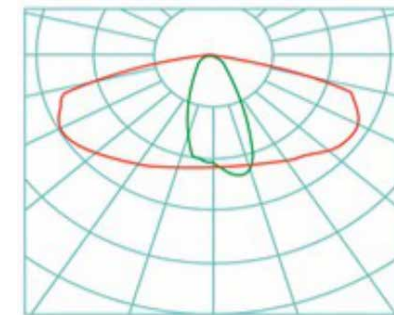

Bat 1

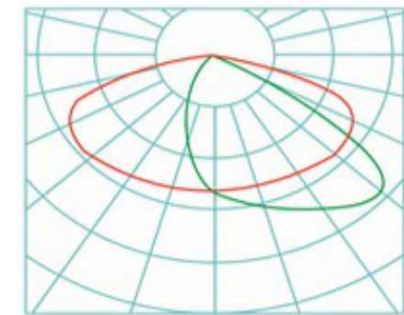

Bat 3

Model	System Power	Modular No.	CCT	Optics Light distribution	Voltage	Options	Size
T20A	40W	1	40K 4000K	B1 Batwing type 1	MV 100-277VAC	DIM Dimming	670x325x180 mm
	80W	2	50K 5000K	B3 Batwing type 3			PH Photocell
	120W	3		120 120 degree	HV 347/480VAC	MS Motion sensor	
	160W	4	80 80 degree	830x325x180 mm			
	200W	5	40 40 degree	910x325x180 mm			
			5700K 57K	25 25 degree			

Note:

The Brand of LED and Driver can be customized due to client's request

The 12/24V DC is possible in 30W/40W for solar&wind power system. For greater wattage, contact for more detail.

We suggest choosing recommended light distributions unless you know how to select it for certain lighting application



# LED STREET LIGHT



SP1016



60mm Hole    IP66 RATING    5 YEAR WARRANTY

## LED Street Light

LED Street light with a round pole mounting hole.

Made of Aluminum alloy with high thermal heat management, design to spread out heat evenly.

Equip with long life, efficient and excellent LED driver and SMD LED, design with maximum distance and greatest heat dissipation through heat sink and heat management system.

Waterproof rate IP65

Built in with protection for short circuit/overload/over voltage/over temperature

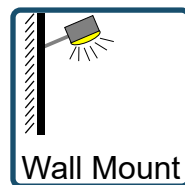
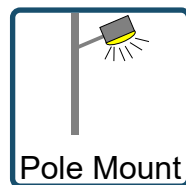

Partner with



# LED STREET LIGHT

## LED Street Light



## Lamp size

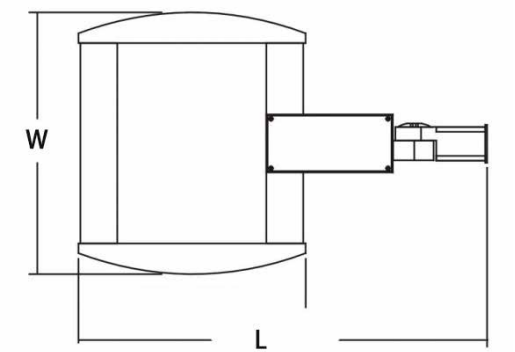

Size | See details in table below

## Light Distribution

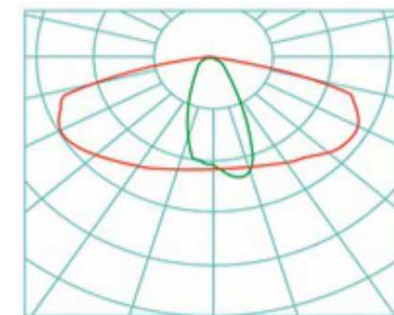

Bat 1

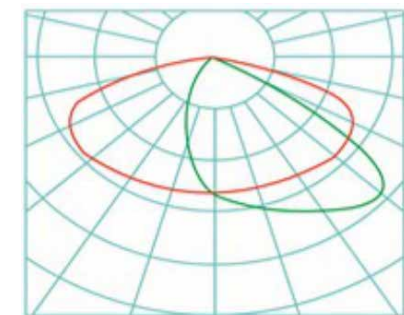

Bat 3

Model	System Power	Modular No.	CCT	Optics Light distribution	Voltage	Options	Size
SP1016	40/60W	2	40K 4000K	B1 Batwing type 1	MV 100-277VAC	DIM Dimming	830x270x105 mm
	80/100W	3		B3 Batwing type 3			830x340x105 mm
	120W	4	50K 5000K	120 120 degree	HV 347/480VAC	PH Photocell	830x415x105 mm
	150W	5		80 80 degree			830x485x105 mm
	200W	6	5700K 57K	40 40 degree	MS Motion sensor	830x555x105 mm	
	250W	7		25 25 degree		830x630x105 mm	
	300W	8			830x700x105 mm		

Note:

The Brand of LED and Driver can be customized due to client's request

The 12/24V DC is possible in 30W/40W for solar&wind power system. For greater wattage, contact for more detail.

We suggest choosing recommended light distributions unless you know how to select it for certain lighting application

# LED STREET LIGHT



SLR14



- 60mm Hole
- IP65 RATING
- 5 YEAR WARRANTY

## LED Street Light

LED Street light with a roud pole mounting hole.

Made of Aluminum alloy with high thermal heat management, design to spread out heat evenly.

Equip with long life, efficient and excellent LED driver and SMD LED, design with maximum distance and greatest heat dissipation through heat sink and heat management system.

Waterproof rate IP65

Built in with protection for short circuit/overload/over voltage/over temperature

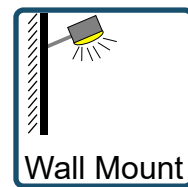
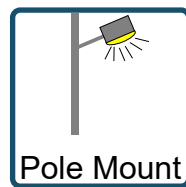

Partner with



# LED STREET LIGHT

## LED Street Light



## Lamp size

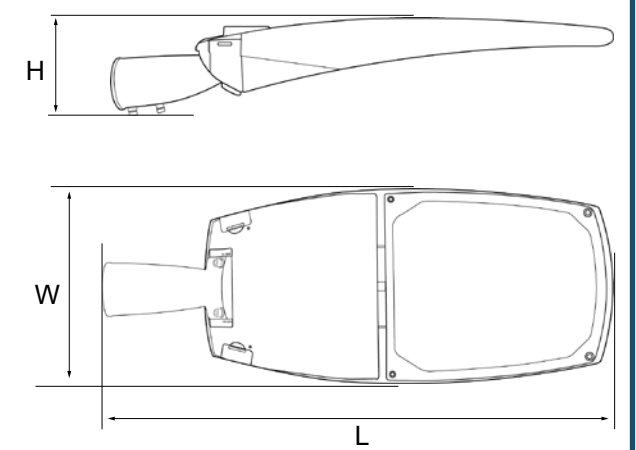

Size | See details in table below

## Light Distribution

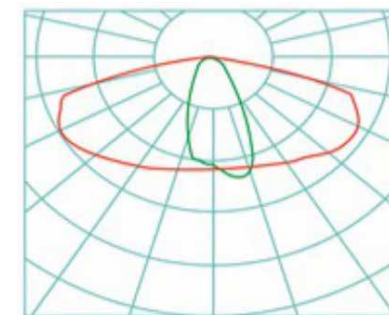

Bat 1

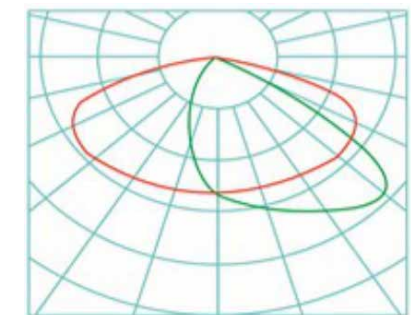

Bat 3

Model	System Power	CCT	Optics Light distribution	Voltage	Options	Size
SLR14	80/100W	40K 4000K	B1 Batwing type 1 B3 Batwing type 3	MV 100-277VAC	DIM Dimming PH Photocell	645x257x147 mm
	120/150/ 180/200W	50K 5000K	120 120 degree 80 80 degree 40 40 degree	HV 347/480VAC	MS Motion sensor	790x305x147 mm
	250/300W	5700K 57K	25 25 degree			890x361x163 mm

Note:

The Brand of LED and Driver can be customized due to client's request

The 12/24V DC is possible in 30W/40W for solar&wind power system. For greater wattage, contact for more detail.

We suggest choosing recommended light distributions unless you know how to select it for certain lighting application