

LED Highbay Light



Bell Shape TF8



IP65 RATING

5 YEAR WARRANTY

LED Highbay Light

LED High bay light with hook mounting.

Made of Aluminum alloy with high thermal heat management, design to spread out heat evenly.

Equip with long life, efficient and excellent LED driver and SMD LED, design with maximum distance and greatest heat dissipation through heat sink and heat management system.

Waterproof rate IP65

Built in with protection for short circuit/overload/over voltage/over temperature

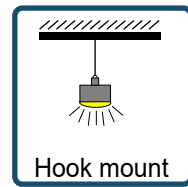

Partner with



LED Highbay Light

LED Highbay Light



Lamp size

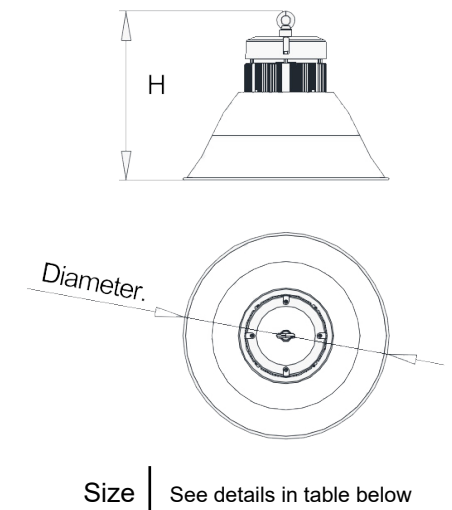

Light Distribution

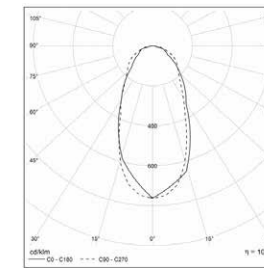

40D

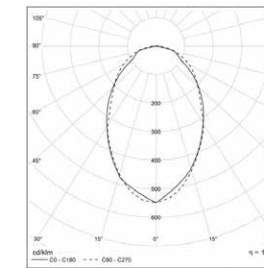

80D

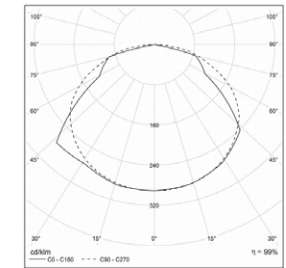

120D

Model	System Power	CCT	Optics Light distribution	Voltage	Options	Size
TF8	60W	40K 4000K	B1 Batwing type 1 B3 Batwing type 3	MV 100-277VAC	DIM Dimming PH Photocell MS Motion sensor	335x325 mm
	80/100/120 150W	50K 5000K	120 120 degree 80 80 degree 40 40 degree 25 25 degree	HV 347/480VAC		490x405mm
	200W	5700K 57K				590x465mm

Note:

The Brand of LED and Driver can be customized due to client's request

The 12/24V DC is possible in 30W/40W for solar&wind power system. For greater wattage, contact for more detail.

We suggest choosing recommended light distributions unless you know how to select it for certain lighting application

LED Highbay Light



TF9



IP65 RATING | 5 YEAR WARRANTY

LED Highbay Light

LED High bay light with hook mounting.

Made of Aluminum alloy with high thermal heat management, design to spread out heat evenly.

Equip with long life, efficient and excellent LED driver and SMD LED, design with maximum distance and greatest heat dissipation through heat sink and heat management system.

Waterproof rate IP65

Built in with protection for short circuit/overload/over voltage/over temperature

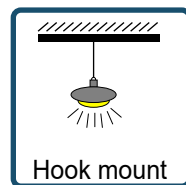

Partner with



LED Highbay Light



LED Highbay Light



Lamp size

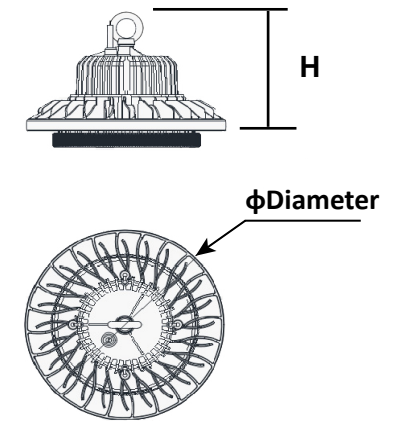

Size | See details in table below

Light Distribution

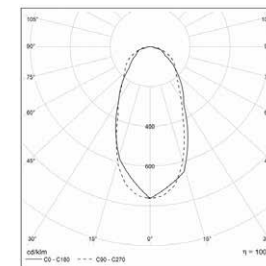

40D

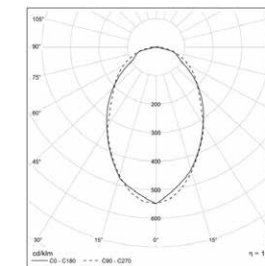

80D

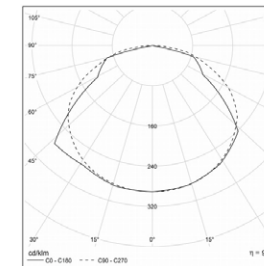

120D

Model	System Power	CCT	Optics Light distribution	Voltage	Options	Size (Diameter)
TF9	60W	40K 4000K	B1 Batwing type 1 B3 Batwing type 3	MV 100-277VAC	DIM Dimming PH Photocell MS Motion sensor	210mm
	80W	50K 5000K	120 120 degree	HV 347/480VAC		250mm
	100W	5700K 57K	80 80 degree			315mm
	120W		40 40 degree			315mm
	150W		25 25 degree			315mm

LED Highbay Light



UFO



IP65
RATING

5 YEAR
WARRANTY

LED Highbay Light

LED High bay light with hook mounting.

Made of Aluminum alloy with high thermal heat management, design to spread out heat evenly.

Equip with long life, efficient and excellent LED driver and SMD LED, design with maximum distance and greatest heat dissipation through heat sink and heat management system.

Waterproof rate IP65

Built in with protection for short circuit/overload/over voltage/over temperature

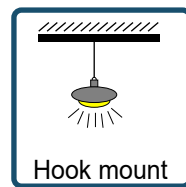

Partner with



LED Highbay Light

LED Highbay Light



Lamp size

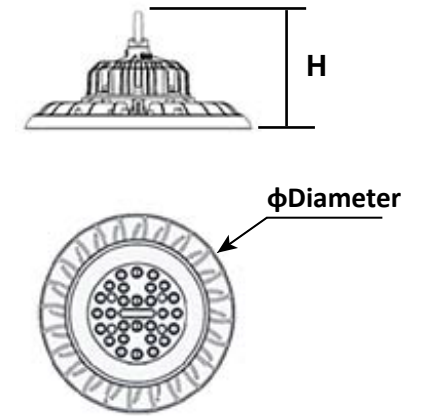

Size | See details in table below

Light Distribution

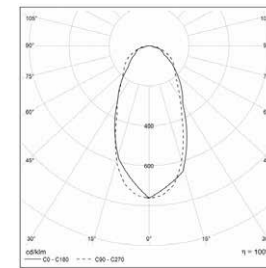

40D

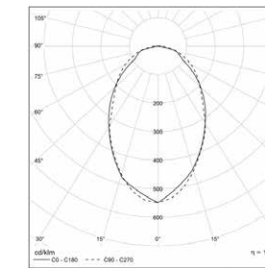

80D

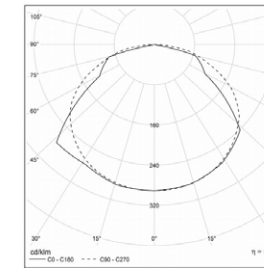

120D

Model	System Power	CCT	Optics Light distribution	Voltage	Options	Size
UFO	100W	40K 4000K	B1 Batwing type 1 B3 Batwing type 3	MV 100-277VAC	DIM Dimming PH Photocell	275x170 mm(DxH)
	150W	50K 5000K	120 120 degree 80 80 degree 40 40 degree	HV 347/480VAC	MS Motion sensor	320x175 mm(DxH)
	200W	5700K 57K	25 25 degree			380x180 mm(DxH)

Note:

The Brand of LED and Driver can be customized due to client's request

The 12/24V DC is possible in 30W/40W for solar&wind power system. For greater wattage, contact for more detail.

We suggest choosing recommended light distributions unless you know how to select it for certain lighting application

LED HIGHBAY LIGHT



SP7009



IP66 RATING 5 YEAR WARRANTY

LED Highbay Light

LED High bay light with hook and Pipe mounting.

Made of Aluminum alloy with high thermal heat management, design to spread out heat evenly.

Equip with long life, efficient and excellent LED driver and SMD LED, design with maximum distance and greatest heat dissipation through heat sink and heat management system.

Waterproof rate IP65

Built in with protection for short circuit/overload/over voltage/over temperature

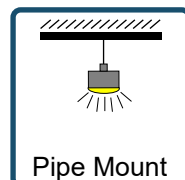
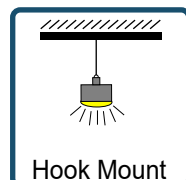

Partner with



LED HIGHBAY LIGHT

LED Canopy Light



Lamp size

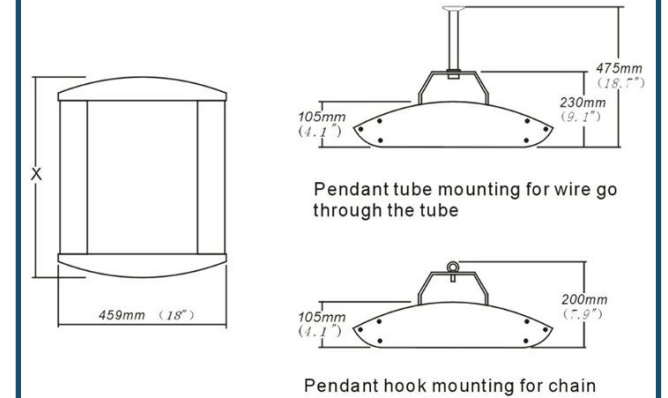

Size | See details in table below

Light Distribution

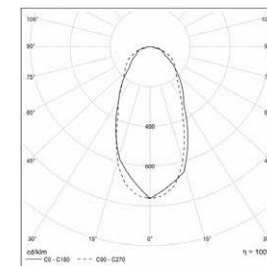

40D

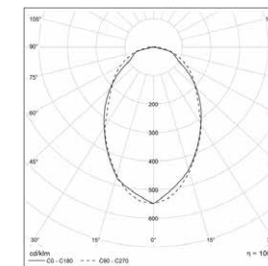

80D

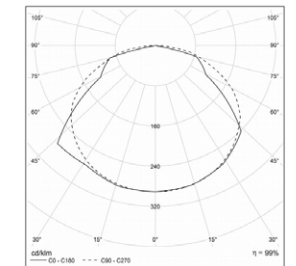

120D

Model	System Power	Modular No.	CCT	Optics Light distribution	Voltage	Options	Size
SP2025	40/60W	2	40K 4000K	B1 Batwing type 1	MV 100-277VAC	DIM Dimming	460x270x200 mm
	80/100W	3		B3 Batwing type 3			460x340x200 mm
	120W	4	50K 5000K	120 120 degree	HV 347/480VAC	PH Photocell	460x415x200 mm
	150W	5		80 80 degree			460x485x200 mm
	200W	6	5700K 57K	40 40 degree	MS Motion sensor	460x555x200 mm	
	250W	7		25 25 degree		460x627x200 mm	
	300W	8			460x700x200 mm		

Note:

The Brand of LED and Driver can be customized due to client's request

The 12/24V DC is possible in 30W/40W for solar&wind power system. For greater wattage, contact for more detail.

We suggest choosing recommended light distributions unless you know how to select it for certain lighting application

LED TRIPROOF LIGHT



GH-A



IP65 RATING

2 YEAR WARRANTY

LED Tri-proof Light

Features

- IP65 waterproof LED light
- Quality LED chips, life time more than 50,000 hours
- Opal PC cover with milky finish or clear finish optional

Application:

Workshop, Warehouse, Cold store, parking-lot, Food industry, Tunnel, Bathroom, etc.

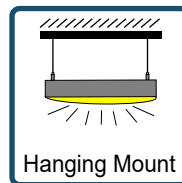

Hanging Mount

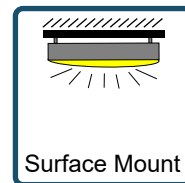

Surface Mount



Warehouse



Indoor area



LED TRIPROOF LIGHT

Light Distribution

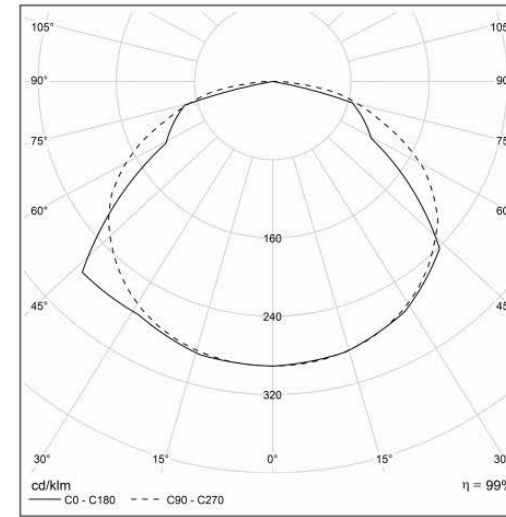

Lamp size

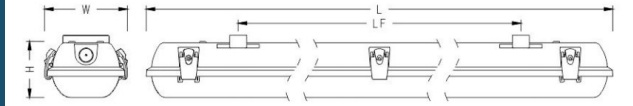

Size | See details in table below

LED Tri-proof Light



Model	System Power	Lumens	Clips Qty	Voltage	Cover	Size
GH-A	19W	1900 lm	6 pcs	220-240VAC 50/60Hz	PC Material	660x117x79 mm
	38W	3800 lm	10 pcs			1260x117x79 mm
	57W	5700 lm	12 pcs			1560x117x79 mm

Note:

The Brand of LED and Driver can be customized due to client's request

The 12/24V DC is possible in 30W/40W for solar&wind power system. For greater wattage, contact for more detail.

We suggest choosing recommended light distributions unless you know how to select it for certain lighting application

LED TRIPROOF LIGHT



GH-H



IP65 RATING 2 YEAR WARRANTY

LED Tri-proof Light

Features

- IP65 waterproof LED light
- Quality LED chips, life time more than 50,000 hours
- Opal PC cover with milky finish or clear finish optional

Application:

Workshop, Warehouse, Cold store, parking-lot, Food industry, Tunnel, Bathroom, etc.

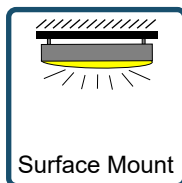
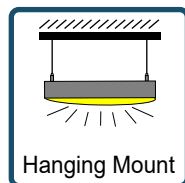

LED TRIPROOF LIGHT

Light Distribution

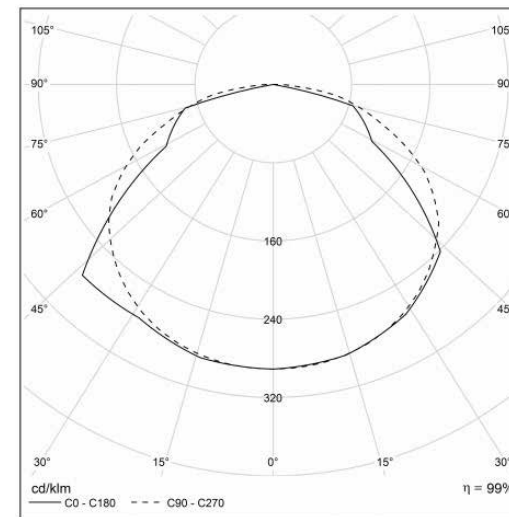

Lamp size

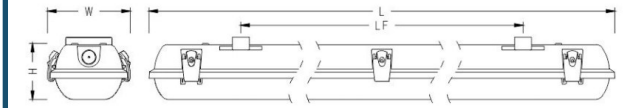

Size | See details in table below

Light Distribution



Model	System Power	Lumens	Clips Qty	Voltage	Cover	Size
GH-H	18W	2300 lm	6 pcs	220-240VAC 50/60Hz	PC Material	650x76x72 mm
	38W	4900 lm	10 pcs			1150x76x72 mm
	57W	7400 lm	12 pcs			1450x76x72 mm

Note:
The Brand of LED and Driver can be customized due to client's request
The 12/24V DC is possible in 30W/40W for solar&wind power system. For greater wattage, contact for more detail.
We suggest choosing recommended light distributions unless you know how to select it for certain lighting application

LED TRIPROOF LIGHT



YP-H3



IP65 RATING

5 YEAR WARRANTY

LED Tri-proof Light

Features

- IP65 waterproof Linear light
- LED T8 Tubes in side
- Single tube & Double tubes optional

Frosted & Clear cover optional

Application:

Workshop, Warehouse, Cold store, parking-lot, Food industry, Tunnel, Bathroom, etc.

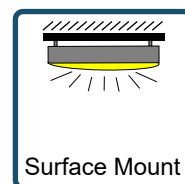
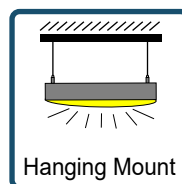

LED TRIPROOF LIGHT

Light Distribution

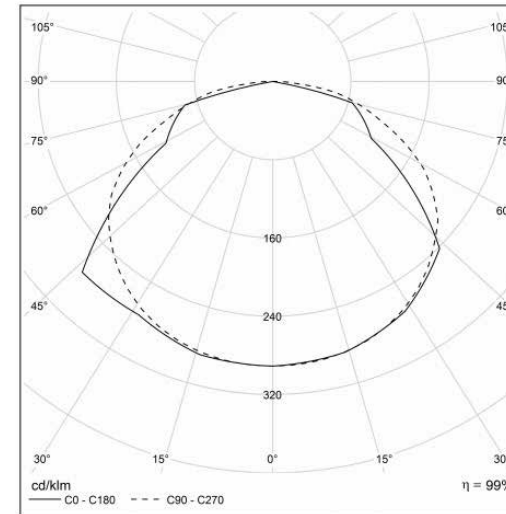

Lamp size

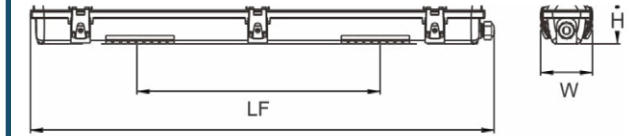

Size | See details in table below

LED Tri-proof Light



Model	System Power	Clips Qty	Tube Qty	Voltage	Cover	Size
YP-H3	1 x 9W	6 pcs	Single tube	220-240VAC 50/60Hz	PC Material	680x75x69 mm
	1 x 18W	10 pcs				1285x75x69 mm
	1 x 25W	12 pcs				1588x75x69 mm
	2 x 9W	6 pcs	Double tubes			680x114x69 mm
	2 x 18W	10 pcs				1285x114x69 mm
	2 x 25W	12 pcs				1588x114x69 mm

Note:

The Brand of LED and Driver can be customized due to client's request

The 12/24V DC is possible in 30W/40W for solar&wind power system. For greater wattage, contact for more detail.

We suggest choosing recommended light distributions unless you know how to select it for certain lighting application

LED TRIPROOF LIGHT



YP-X



IP65 RATING

2 YEAR WARRANTY

LED Tri-proof Light

Features

- IP65 waterproof Linear light
- LED T8 Tubes in side
- Single tube & Double tubes optional

Frosted & Clear cover optional

Application:

Workshop, Warehouse, Cold store, parking-lot, Food industry, Tunnel, Bathroom, etc.

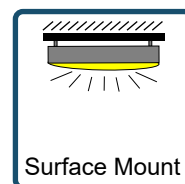
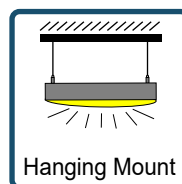

LED TRIPROOF LIGHT

Light Distribution

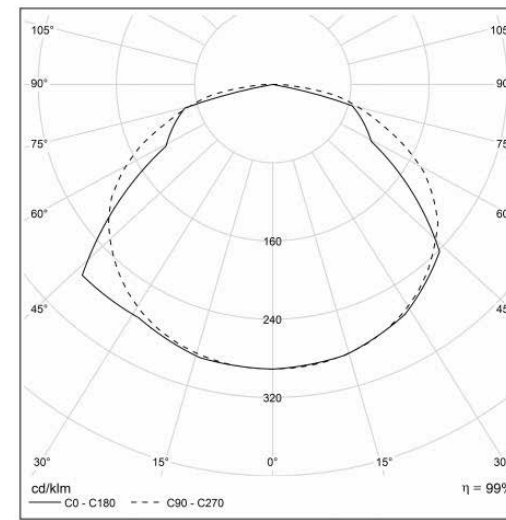

Lamp size

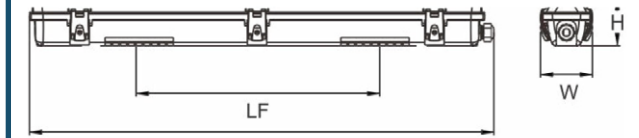

Size | See details in table below

LED Tri-proof Light



Model	System Power	Clips Qty	Tube Qty	Voltage	Cover	Size
YP-X	1 x 9W	6 pcs	Single tube	220-240VAC 50/60Hz	PC Material	655x75x86 mm
	1 x 18W	10 pcs				1265x75x86 mm
	1 x 25W	12 pcs				1560x75x86 mm
	2 x 9W	6 pcs	Double tubes			655x113x86 mm
	2 x 18W	10 pcs				1265x113x86 mm
	2 x 25W	12 pcs				1560x113x86 mm

Note:

The Brand of LED and Driver can be customized due to client's request

The 12/24V DC is possible in 30W/40W for solar&wind power system. For greater wattage, contact for more detail.

We suggest choosing recommended light distributions unless you know how to select it for certain lighting application

LED TRIPROOF LIGHT



YP-F



IP65 RATING

2 YEAR WARRANTY

LED Tri-proof Light

Features

- IP65 waterproof Linear light
- LED T8 Tubes in side
- Four tubes setting inside

Frosted & Clear cover optional

Application:

Workshop, Warehouse, Cold store, parking-lot, Food industry, Tunnel, Bathroom, etc.

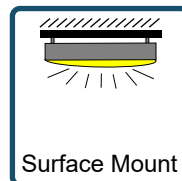
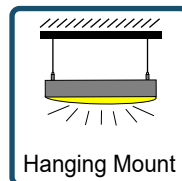

LED TRIPROOF LIGHT

Light Distribution

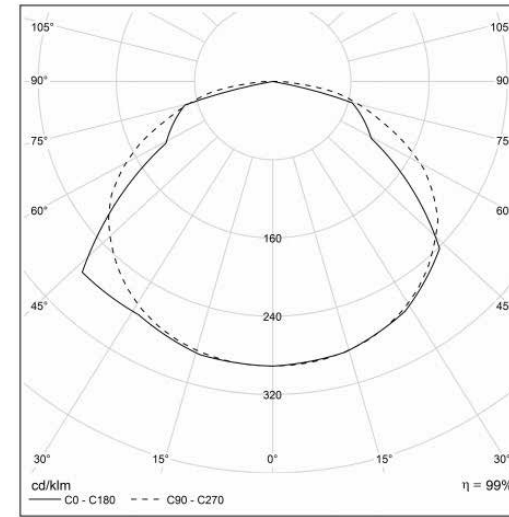

Lamp size

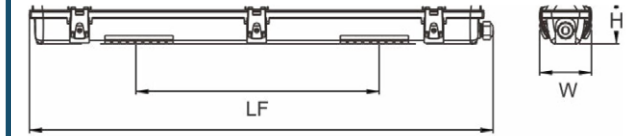

Size | See details in table below

LED Tri-proof Light



FOUR TUBES



Model	System Power	Tube Qty	Clips Qty	Voltage	Cover	Size
YP-F	4x18W	1900 lm	10 pcs	220-240VAC 50/60Hz	PC Material	1260x180x105 mm

Note:

The Brand of LED and Driver can be customized due to client's request

The 12/24V DC is possible in 30W/40W for solar&wind power system. For greater wattage, contact for more detail.

We suggest choosing recommended light distributions unless you know how to select it for certain lighting application